

# Turmdrehkran

Tower Crane / Grue à tour / Gru a torre / Grúa torre /  
Guindaste de torre / Кран башенный

## 370 EC-B 12 Fibre

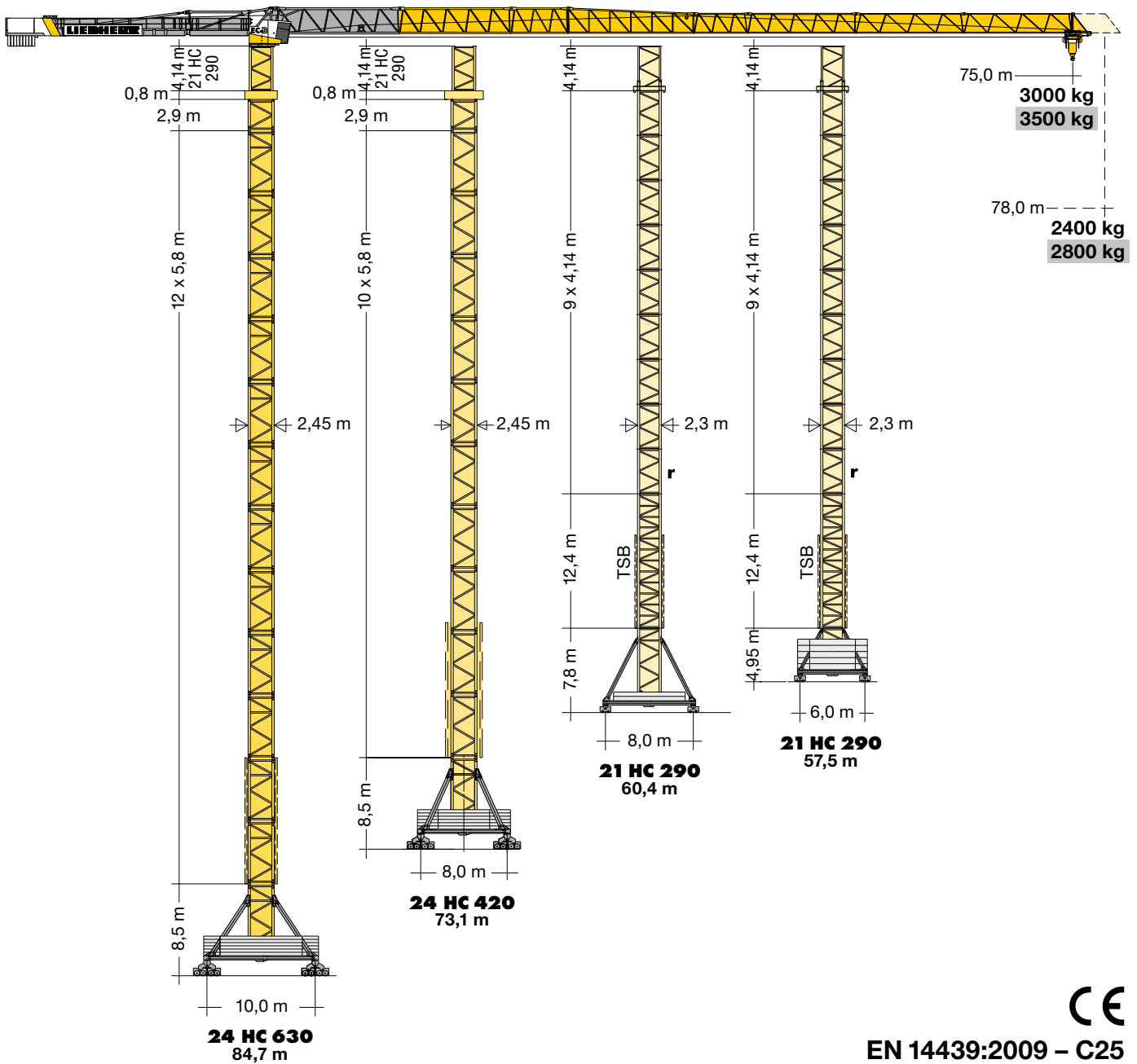

# LIEBHERR

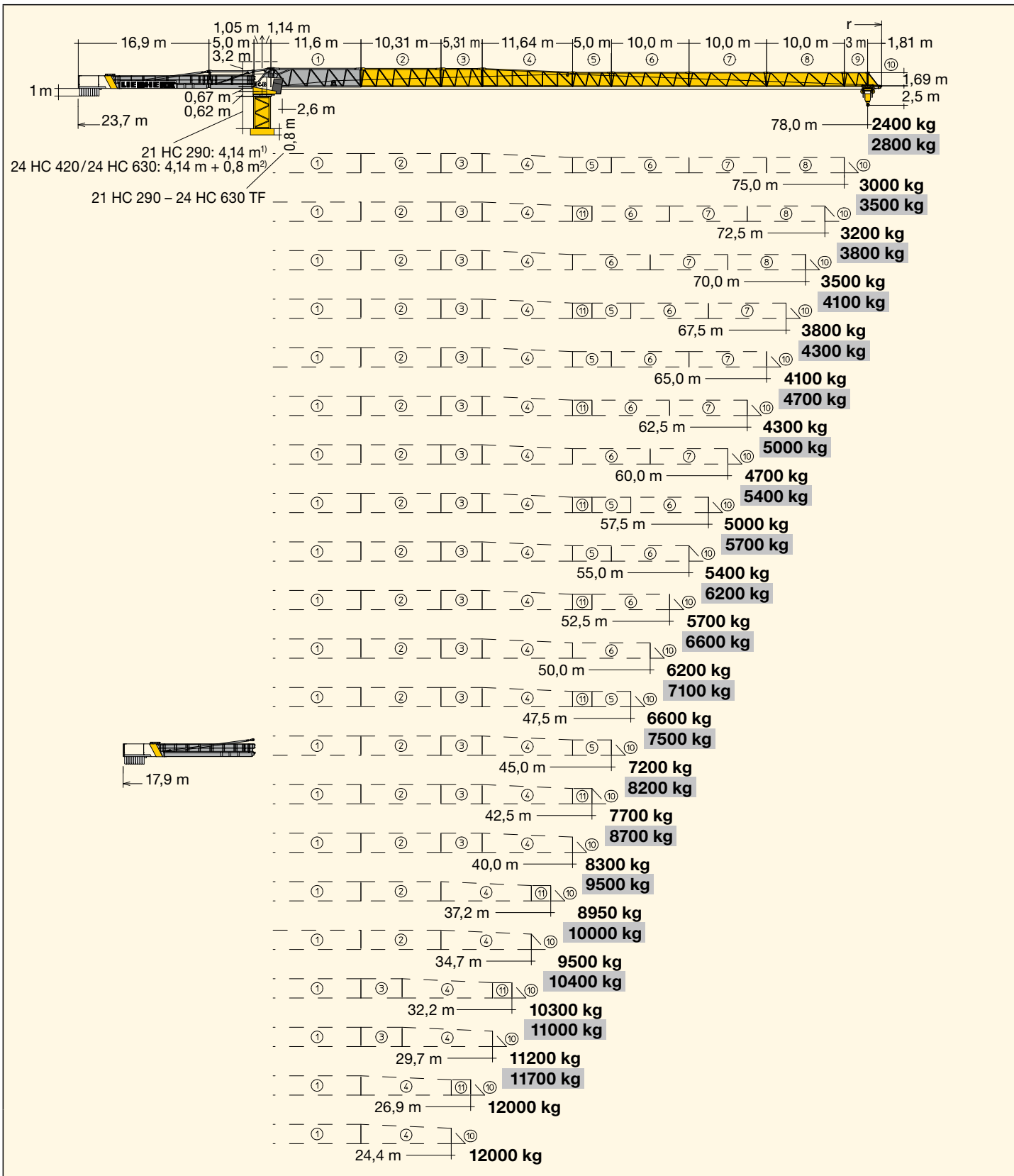

1) Turmstück oder Kletterturmstück / Tower section or climbing tower section / Élément de mât ou élément de mât télescopable / Elemento torre oppure elemento torre telescopabile / Tramo torre o tramo torre trepable / Segmento de torre ou segmento de torre para ascensão / Башенная секция или секция наращивания

2) Turmstück 21 HC 290 + Übergangsrahmen 21 HC 290 – 24 HC 630 TF / Tower section 21 HC 290 + transition frame 21 HC 290 – 24 HC 630 TF / Élément de mât 21 HC 290 + cadre de raccordement 21 HC 290 – 24 HC 630 TF / Elemento di torre 21 HC 290 + Adattatore torre 21 HC 290 – 24 HC 630 TF / Tramo torre 21 HC 290 + Marco de transición 21 HC 290 – 24 HC 630 TF / Segmento de torre 21 HC 290 + Quadro de transição 21 HC 290 – 24 HC 630 TF / Башенная секция 21 HC 290 + Переходная рама 21 HC 290 – 24 HC 630 TF

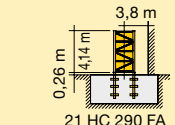
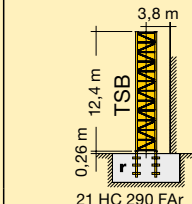
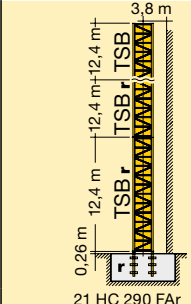
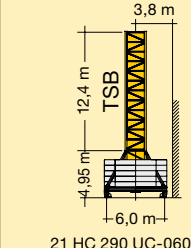
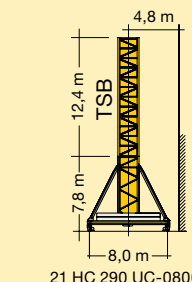

4,14 m		4,14 m + 2,07 m	<b>21 HC 290</b>				
							
10		-	57,0 <sup>*)4)</sup>	-	-	-	-
9	9 + 1	40,4 <sup>*)</sup>	54,9 <sup>*)4)</sup>	-	-	57,5 <sup>*)3)</sup>	60,4 <sup>*)3)</sup>
8	8 + 1	38,3 <sup>*)</sup>	52,8 <sup>*)3)</sup>	-	-	55,5 <sup>*)</sup>	58,3 <sup>*)</sup>
7	7 + 1	36,3	50,8 <sup>*)</sup>	-	-	53,4 <sup>*)</sup>	56,2 <sup>*)</sup>
6	6 + 1	34,2	48,7 <sup>*)</sup>	-	-	51,3	54,2
5	5 + 1	32,1	46,6	69,4 <sup>*)</sup>	-	49,2	52,1
4	4 + 1	30,1	44,5	67,3 <sup>*)</sup>	-	47,2	50,0
3	3 + 1	28,0	42,5	65,3	-	45,1	48,0
2	2 + 1	25,9	40,4	63,2	-	43,0	45,9
1	1 + 1	23,8	38,3	61,1	-	41,0	43,8
0	0 + 1	21,8	36,3	59,0	-	38,9	41,7
		19,7	34,2	57,0	-	36,8	39,7
		17,6	32,1	54,9	-	34,8	37,6
		15,6	30,1	52,8	-	32,7	35,5
		13,5	28,0	50,8	-	30,6	33,4
		11,4	25,9	48,7	-	28,5	31,4
		9,4	23,9	46,6	-	26,5	29,3
		7,3	21,8	44,5	-	24,4	27,2
		5,2	19,7	42,5	-	22,3	25,2
		3,2	17,6	40,4	-	20,3	23,1
			m	m	m	m	m
							

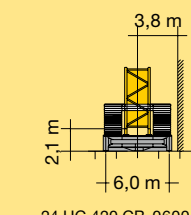
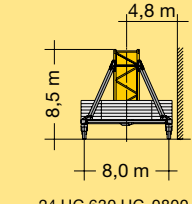
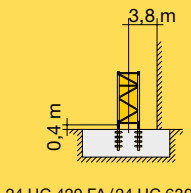
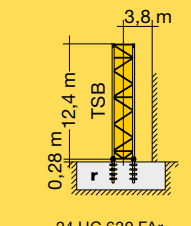
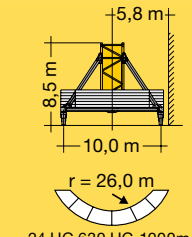
5,8 m		5,8 m + 2,9 m	<b>24 HC 420</b>		<b>24 HC 420 / 24 HC 630</b>	<b>24 HC 630</b>	
							
13	13 + 1	-	-	-	82,4 <sup>*)8)</sup>	-	-
12	12 + 1	-	-	-	79,5 <sup>*)7)</sup>	91,7 <sup>*)</sup>	-
11	11 + 1	-	-	-	76,6 <sup>*)7)</sup>	88,8 <sup>*)</sup>	84,7 <sup>*)</sup>
10	10 + 1	66,7 <sup>*)</sup>	73,1 <sup>*)</sup>	-	73,7 <sup>*)6)</sup>	85,9	81,8 <sup>*)</sup>
9	9 + 1	63,8 <sup>*)</sup>	70,2 <sup>*)</sup>	-	70,8 <sup>*)6)</sup>	83,0	78,9
8	8 + 1	60,9	67,3	-	67,9 <sup>*)5)</sup>	80,1	76,0
7	7 + 1	58,0	64,4	-	65,0 <sup>*)</sup>	77,2	73,1
6	6 + 1	55,1	61,5	-	62,1 <sup>*)</sup>	74,3	70,2
5	5 + 1	52,2	58,6	-	59,2	71,4	67,3
4	4 + 1	49,3	55,7	-	56,3	68,5	64,4
3	3 + 1	46,4	52,8	-	53,4	65,6	61,5
2	2 + 1	43,5	49,9	-	50,5	62,7	58,6
1	1 + 1	40,6	47,0	-	47,6	59,8	55,7
0	0 + 1	37,7	44,1	-	44,7	56,9	52,8
		34,8	41,2	-	41,8	54,0	49,9
		31,9	38,3	-	38,9	51,1	47,0
		29,0	35,4	-	36,0	48,2	44,1
		26,1	32,5	-	33,1	45,3	41,2
		23,2	29,6	-	30,2	42,4	38,3
		20,3	26,7	-	27,3	39,5	35,4
		17,4	23,8	-	24,4	36,6	32,5
		14,5	20,9	-	21,5	33,7	29,6
		11,6	18,0	-	18,6	30,8	26,7
		8,7	15,1	-	15,7	27,9	23,8
		5,8	12,2	-	12,8	25,0	20,9
			m	m	m	m	m
							

**Turmstücke 24 HC 630 müssen am Turmfuß eingebaut werden. Details siehe Bedienungsanleitung.** / Tower sections 24 HC 630 must be installed on the tower base. See operating manual for further details. / Les éléments de mât 24 HC 630 doivent être montés en pied de grue. Voir les détails dans les instructions d'emploi. / Elementi torre 24 HC 630 devono essere montati alla base torre. Si veda il manuale istruzioni per i dettagli. / Los tramos torre de la 24 HC 630 tienen que ser montados en el pie de torre. Más detalles en las instrucciones de montaje. / Segmentos de torre 24 HC 630 devem ser instalados sobre o segmento base. Para mais detalhes consultar manual de instrução. / Башенные секции 24 HC 630 должны монтироваться в основании башни. Подробную информацию смотрите в инструкции по эксплуатации.

- \*)
- 3) 1 x 21 HC 290 TS-0414cr
  - 4) 2 x 21 HC 290 TS-0414cr
  - 5) 1 x 24 HC 630 TS-0580c
  - 6) 2 x 24 HC 630 TS-0580c
  - 7) 3 x 24 HC 630 TS-0580c
  - 8) 4 x 24 HC 630 TS-0580c

**Weitere Hubhöhen, Auslegerlängen sowie Klettern im Gebäude auf Anfrage.** / Further hoist heights and jib lengths as well as climbing inside the building on request. / Autres hauteurs sous crochet et longueurs de flèche ainsi que hissage dans le bâtiment sur demande. / Ulteriori altezze gancho, lunghezze braccio così come telescopaggio all'interno dell'edificio: su richiesta. / Para alturas bajo gancho superiores, otros alcances y trepado en el interior del edificio, consultar. / Outras alturas de elevação, comprimentos de lança e subida no edifício: sob consulta. / Другие высоты подъема, длины стрелы и самоподъем в здании – по запросу.

**r = verstärkt / reinforced / renforcé / rinforzato / reforzado / reforçado / усиленный**

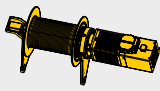
	↔ <b>stufenlos / stepless / régl. continu / regl. progressiva / sin escalones / sem degraus / бесступенчатый</b> kg m/min
45 kW FU FSW 260 MZ 004 <b>5 Lagen</b> Layers Couches Avvolgimenti Camadas Capas Слоёв 182,0 m max. 269,0 m <sup>9)</sup>	<b>1</b> 12000 0 ↔ 20 1100 0 ↔ 119

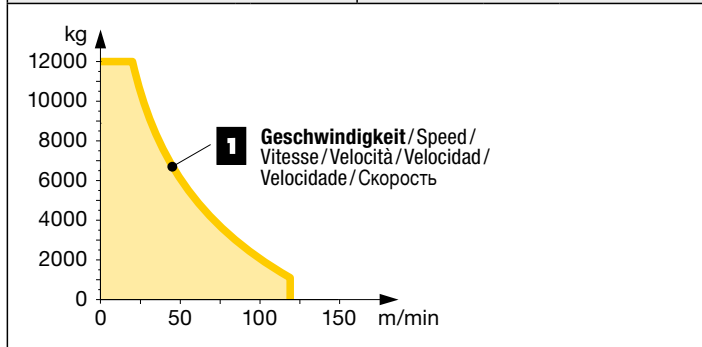

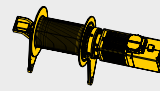

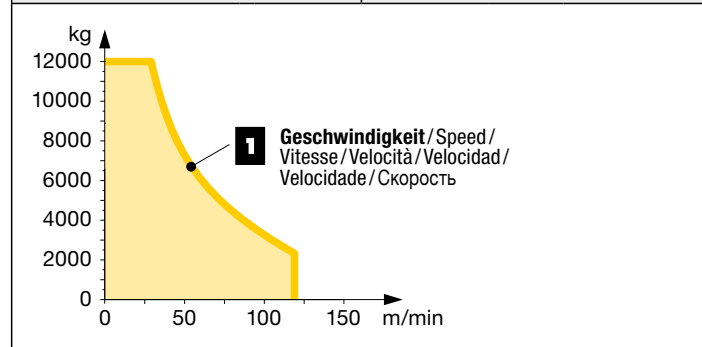
	↔ <b>stufenlos / stepless / régl. continu / regl. progressiva / sin escalones / sem degraus / бесступенчатый</b> kg m/min
65 kW FU FSW 280 MZ 001 <b>5 Lagen</b> Layers Couches Avvolgimenti Camadas Capas Слоёв 182,0 m max. 269,0 m <sup>9)</sup>	<b>1</b> 12000 0 ↔ 29 2300 0 ↔ 119

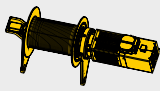

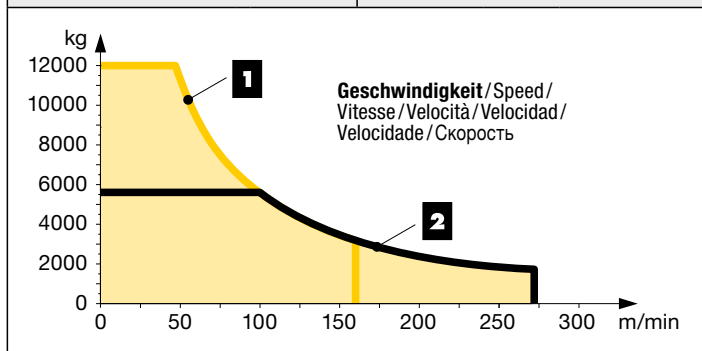
	↔ <b>stufenlos / stepless / régl. continu / regl. progressiva / sin escalones / sem degraus / бесступенчатый</b> kg m/min
110 kW FU <b>SD.shift</b> FSW 300 WZ 001 <b>5 Lagen</b> Layers Couches Avvolgimenti Camadas Capas Слоёв 182,0 m max. 269,0 m <sup>9)</sup>	<b>1</b> 12000 0 ↔ 49 3200 0 ↔ 160 <b>2</b> 5600 0 ↔ 100 1700 0 ↔ 272

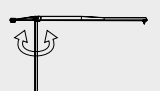
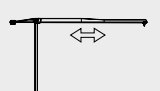



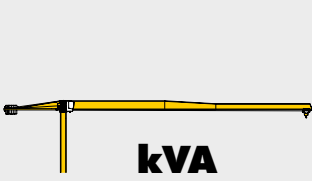

























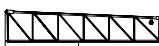



























	0 ↔ 0,7 U/min sl./min tr./min	2 x 7,5 kW FU
	0 ↔ 109,0 m/min	7,5 kW FU
	25,0 m/min	2 x 7,5 kW (21 HC 290) 4 x 7,5 kW (24 HC 420/ 24 HC 630)

	<b>kVA</b>	45 kW FU 65,0	65 kW FU 86,0	110 kW FU 122,0
--	------------	------------------	------------------	--------------------



<sup>9)</sup> Weitere Hublastdaten: siehe Betriebsanleitung. / Further hoist load data: see instruction manual. / Autres données de la charge de levage : voir manuel d'instruction. / Altri dati sui carichi sollevati: consultare il manuale d'istruzione. / Alturas bajo granchos superiores según manual. / Outras tabelas de carga: consultar manual de instruções. / Другие данные по весу поднимаемых грузов: см. инструкцию по эксплуатации.

**kVA reduzierbar bei zu geringer Netz-Anschlussleistung, siehe BAL. / kVA can be reduced in case of too little power of the mains, see instruction manual. / kVA peut être réduit en cas de trop faible puissance du réseau, voir manuel d'instruction. / kVA riducibili in caso di potenza di rete ridotta (si veda manuale uso e manutenzione) / kVA variable para potencia de red demasiado pequeña, ver Manual de instrucciones. / kVA reduzível no caso de capacidade da rede elétrica muito baixa, ver manual de instruções. / Количество кВА может быть сокращено до минимальной общей потребляемой мощности, см. инструкцию по эксплуатации.**

<b>Kranoberteil</b>		Upper part of crane / Partie supérieure de grue / Parte superiore della gru / Parte superior grúa / Parte superior do guindaste / Верхняя часть крана	L (m)	B (m)	H (m)	kg <sup>(10)</sup>		
Pos. Item Rep Voce Pos. Ref. Поз.	Anz. Qty. Qte. Qta. Cant. Cant. Кол-во	<b>Drehbühne kpl. mit Kugeldrehkranz und KUD-Auflage 21 HC 290 mit Klappspitze, Kabine und Schaltschrank mit Podesten</b> / Slewing platform complete with slewing ring and slewing ring support 21 HC 290 with folding head, cabin and switch cabinet with platforms / Plate-forme tournante complète avec couronne d'orientation et pivot d'orientation 21 HC 290 avec pointe pliante, cabine et armoire électrique avec plates-formes / Piattaforma girevole con ralla e supporto ralla 21 HC 290 con punta ribaltabile, cabina e quadro elettrico con pedane / Plataforma giratoria completa con corona de rotación y asiento de pista 21 HC 290 con punta abatible y armario eléctrico con plataforma / Plataforma de giro completa com coroa de giro e assento da coroa 21HC 290, com cavalete dobrável, cabine e painel elétrico com plataformas / Поворотная платформа в сб. с шариковым поворот- ным кругом и рамой ОПУ 21 HC 290 с откидным кронштейном, кабиной и распределительным электрошкафом с площадками			6,57	2,42	2,55	11800
1	1							
1a	1	<b>Drehbühne mit Kugeldrehkranz und KUD-Auflage 21 HC 290</b> / Slewing platform with slewing ring and slewing ring support 21 HC 290 / Plate-forme tournante avec couronne d'orientation et pivot d'orientation 21 HC 290 / Piattaforma girevole con ralla e supporto ralla 21 HC 290 / Plataforma giratoria con corona de rotación y asiento de pista 21 HC 290 / Plataforma de giro com coroa de giro e assento da coroa 21 HC 290 / Поворотная платформа с шариковым поворотным кругом и рамой ОПУ 21 HC 290			3,67	2,39	2,45	7050
1b	1	<b>Schaltschrank mit Podest</b> / Switch cabinet with platform / Armoire électrique avec plate-forme / Quadro elettrico con pedana / Armario eléctrico con plataforma / Armário elétrico com plataforma / Электрошкаф с площадкой			2,31	2,19	1,95	1550
1c	1	<b>Kabine mit Podest</b> / Cabin with platform / Cabine avec plate-forme / Cabina con pedana / Cabina con plataforma / Cabina com plataforma / Кабина с площадкой			2,40	2,09	2,47	1700
1d	1	<b>Klappspitze</b> / Folding head / Pointe pliante / Punta ribaltabile / Pluma / Cavalete dobrável / Откидной кронштейн			1,86	1,45	2,34	1500
2	1	<b>Gegenausleger lang</b> / Counter-jib, long / Contre-flèche longue / Controffrecia lunga / Contrapluma larga / Contra-lança, longa / Консоль противовеса, длинная			11,89	2,33	3,01	16100
2a	1	<b>Gegenausleger kurz</b> / Counter-jib, short / Contre-flèche courte / Controffrecia corta / Contrapluma corta / Contra-lança, curta / Консоль противовеса, короткая			11,89	2,33	2,67	12600
2b	1	<b>Gegenausleger-Zwischenstück</b> / Intermediate counter-jib section / Elément interm. de contre-flèche / Spezzone di controbraccio / Tramo intermedio de contrapluma / Peça suplementar da contra- lança / Промежуточная секция консоли противовеса			6,26	1,85	2,45	3500
3	1	<b>Ausleger-Anlenkstück</b> / Jib heel section / Pied de flèche / Sezione articolata braccio / Pluma tramo primero / Base articulada de lança / Корневая секция стрелы			11,92	1,28	2,53	① 5300
4	1	<b>Ausleger-Zwischenstück</b> / Intermediate jib section / Elément intermédiaire de flèche / Sezione intermedia braccio / Tramo intermedio pluma / Peça suplementar da lança / Промежуточная секция стрелы			10,65 5,64	1,28 1,28	2,48 2,47	② 2700 ③ 1150
5	1	<b>Ausleger-Zwischenstück</b> / Intermediate jib section / Elément intermédiaire de flèche / Sezione intermedia braccio / Tramo intermedio pluma / Peça suplementar da lança / Промежуточная секция стрелы			11,94	1,28	2,45	④ 2050
6	1	<b>Ausleger-Zwischenstück</b> / Intermediate jib section Elément intermédiaire de flèche / Sezione intermedia braccio / Tramo intermedio pluma / Peça suplementar da lança / Промежуточная секция стрелы			5,28 10,25 10,23 10,22 3,22 2,78	1,28 1,28 1,28 1,28 1,28 1,28	1,95 1,95 1,94 1,93 1,93 1,95	⑤ 760 ⑥ 1280 ⑦ 850 ⑧ 660 ⑨ 240 ⑩ 460
7	1	<b>Ausleger-Kopfstück</b> / Jib head section / Pointe de flèche / Punta braccio / Tramo punta de pluma / Cabeça de lança / Концевая секция стрелы			1,91	1,28	2,12	⑪ 260
8	1	<b>Laufkatze und Lsthaken</b> / Trolley and hook / Chariot de distribution et crochet / Carrello con gancio / Carrito y gancho / Carro de ponte e gancho / Грузовая тележка и грузовой крюк			2,06	1,62	1,71	565
9	1	<b>Fahrkorb</b> / Maintenance cage / Nacelle d'entretien / Cestello di manutenzione / Plataforma de mantenimiento / Передвижная платформа			0,66	0,57	1,17	25

Pos. Item Rep Voce Pos. Ref. Поз.	Anz. Qty. Qte. Qta. Cant. Cant. Кол-во				L (m)	B (m)	H (m)	kg <sup>(10)</sup>	
<b>Turm</b>		<b>Tower / Mât / Torre Torre / Torre / Башня</b>							
10	1	<b>Turmstück / Tower section /</b> Elément de mât / Elemento di torre / Tramo torre / Torre / Башенная секция	 	 	21 HC 290 TS-0414c 4,14 21 HC 290 TS-0414cr 4,14 21 HC 290 TS-1242c 12,42 24 HC 420 TS-0290c 3,19 24 HC 420 TS-0580c 6,09 24 HC 420 TS-1160 11,90 24 HC 630 TS-0290c 3,38 24 HC 630 TS-0580c 6,28 24 HC 630 TS-1160 12,10	4,14 2,30 2,30 2,30 2,45 2,45 2,45 2,45 2,45 2,45	2,30 2,30 2,30 2,45 2,45 2,45 2,45 2,45 2,45	2500 2950 6100 2950 4500 7200 4050 6450 10750	
11	1	<b>Grundturmstück / Base tower section /</b> Mât de base / Elemento di torre base / Tramo base / Peça de base de torre / Секция основания			21 HC 290 TSB-1242c 12,42 24 HC 630 TSB-1242c 12,42 24 HC 630 TSB-1242r 12,42	12,42 2,68 2,68	2,30 2,68 2,68	8200 14500 17300	
12	1	<b>Kletterturmstück / Climbing tower section /</b> Elément de hissage de mât / Elemento torre di telescopaggio / Tramo de trepado / Tramo de telescopagem / Секция самоподъема			21 HC 290 ECTS-0414 4,14	4,14	2,30	2,45	3300
13	1	<b>Übergangsrahmen / Transition frame /</b> Cadre de raccordement / Adattatore torre / Chasis de unión / Quadro adaptador / Переходная рама			21 HC 290 – 24 HC 630 TF-0080	3,16	2,85	1,08	3700
<b>Klettereinrichtung</b>		<b>Climbing equipment / Equipement de télescopage / Attrezzatura per allungamento della gru / Equipo de trepado / Acsórios p. subida no edificio / Обойма наращивания</b>							
14	1	<b>Führungsstück kpl., geteilt / Guide section cpl., split /</b> Cage télescopique cpl., devisée / Gabbia de sopraelevazione compl., suddivisa / Torre de montaje completa, dividida / Peça de guia compl., subdividida / Направляющая секция в сб., разъемная			21 HC 290 ECGS 8,39 24 HC 630 ECGS 12,39	8,39 12,39	2,75 2,78	2,70 (3,04) 1,58	5800 8550
15	1	<b>Hydraulikanlage, Stütz- und Klettertraverse /</b> Hydraulic unit, supporting and climbing crossmembers / Système hydraul. avec traverses d'appui et de télescop. / Sist. idraul., traversa di appoggio e allugam. gru / Sistema hidráulico con traviesa de apoyo y trepado / Instalação hidráulica, tavessa de apoio e subida / Гидроагрегат, стойка-упор и траверса обоймы наращивания			21 HC 290 2,10 24 HC 630 2,60	2,10 2,60	1,25 1,50	1,00 1,00	1150 1900
<b>Unterwagen</b>		<b>Undercarriage / Châssis / Carro / Carro con mástil / Carro de guindaste / Опорная рама</b>							
16	4	<b>Ausgleichsschwinge mit Schwingenlager /</b> Pivot for wheel box / Chape pour bogie / Bilanciere di equilibratura con cuscinetto bilanciere / Balancin / Balancim com suporte / Балансир с шарнирной опорой			24 HC 630	1,60	0,72	1,48	1470
17	2	<b>Fahrschemel mit Antrieb / Rail bogie with drive /</b>			21 HC 290	1,63 (1,46)	0,92 (0,84)	0,95 (0,87)	1690 (920)
4	4	<b>Bogie moteur / Telaio con gruppo propulsore /</b> Caja rodillo motriz / Quadra sem grupa de propulsão / Подрамник с приводом			24 HC 630	1,45	0,82	0,72	1200
18	2	<b>Fahrschemel ohne Antrieb / Rail bogie without</b>			21 HC 290	1,37 (1,15)	0,62 (0,60)	0,95 (0,87)	1340 (880)
4	4	<b>drive / Bogie fou / Telaio senza gruppo propulsore /</b> Caja rodillo conducido / Quadra com grupa de propulsão / Подрамник без привода			24 HC 630	1,30	0,40	0,72	950
19	2	<b>Tragholm lang / Long support arm / Longeron long /</b>			21 HC 290	9,10 (11,95)	0,80 (0,82)	0,80 (0,80)	1650 (2200)
2	2	<b>Longherone lungo / Brazo soporte largo /</b>			24 HC 630	7,32 (5,91)	0,92 (0,92)	0,93 (0,93)	2330 (1980)
2	2	<b>Travessa comprida / Несущая балка, длинная</b>							
20	2	<b>Tragholm kurz / Short support arm / Longeron</b>			21 HC 290	4,45 (5,58)	0,77 (0,65)	0,77 (0,77)	800 (1040)
2	2	<b>court / Longherone corto / Brazo soporte corto /</b>			24 HC 630	7,14 (5,73)	0,92 (0,80)	0,90 (0,90)	2180 (1780)
2	2	<b>Travessa curta / Несущая балка, короткая</b>							
21	2+2	<b>Randträger / Border support / Traverse /</b>			21 HC 290	5,46 – 5,40 (7,52 – 7,46)	0,11 – 0,18 (0,10 – 0,17)	0,16 – 0,38 (0,10 – 0,38)	175 – 525 (370 – 915)
2	2	<b>Supporti base Traviesas / Apoio de bordo /</b>			24 HC 630	9,30 (7,30)	0,24 (0,14)	0,41 (0,14)	870 (400)
2	2	<b>Stяжная балка</b>							
22	4	<b>Stützholm / Support strut / Hauban de châssis /</b>			21 HC 290	4,14 (6,55)	0,18 (0,22)	0,25 (0,25)	320 (600)
4	4	<b>Correnti di appoggio / Tirante vertical /</b>			24 HC 630	6,98 (6,05)	0,26 (0,26)	0,39 (0,39)	1190 (1140)
4	4	<b>Travessa de apoio / Опорный подкос</b>							
23	1	<b>Unterwagen-Turmstück / Undercarriage</b>			21 HC 290	3,73 (6,70)	2,62 (2,53)	2,62 (2,53)	2920 (4030)
1	1	<b>tower section / Mât de châssis / Elemento</b>			24 HC 630	6,61	2,44	2,44	7930
1	1	<b>di torre del carro / Tramo de carro / Peça</b>							
1	1	<b>de torre do chassis / Опорная башенная секция</b>							
24		<b>Kleinteile, Seile und Abspannungen / Small parts, ropes and holding bars /</b>			21 HC 290	9,00	1,60	1,00	4000
		<b>Accessoires, câbles et tirants / Accessori, funi e attrezzi di ancoraggio /</b>			24 HC 630				
		<b>Despieces, cables y tirantes / Acsórios, cabos e peças de ancoragem /</b>							
		<b>Мелкие детали, Канаты и Пристежки</b>							

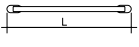
Pos. Anz.  
Item Qty.  
Rep. Qte.  
Voce Qta.  
Pos. Cant.  
Ref. Cant.  
Поз. Кол-во

				L (m)	B (m)	H (m)	kg <sup>10)</sup>	
<b>Fundamentkreuz</b>		<b>Cruciform base/Châssis en croix/Crociera/ Carro de guindaste/Base cruciforme/Фундаментная крестовина</b>						
25	2	<b>Hauptträger</b> / Main beam / Poutre principale / Traversa portante / Viga principal / Travessa comprida / основная балка		24 HC 420 CB-0600	9,20	1,10	1,53	8300
26	2	<b>Randträger</b> / Border support / Traverse / Supporti base / Traviesa / Apoio de bordo / Стяжная балка		24 HC 420 CB-0600	5,50	0,25	0,66	560
27	4	<b>Adapter HC-Turm</b> / Adapter for HC tower / Adaptateur pour mât HC / Adattatore torre HC / Tramo transición HC / Adaptador para torre HC / Переходной элемент башни HC		24 HC 420 CB-0600	0,43	0,43	0,64	320

( ) **Angaben in Klammern gelten für 8 m-Unterwagen.** / The data in brackets are valid for an undercarriage of 8 m. / Les données techniques indiquées entre parenthèses sont valables pour un châssis de 8 m. / Caratteristiche in (..) valgono per carro di 8 m. / Los datos entre paréntesis son válidos para carro de 8 m. / Características em (..) válidas pelo chassis de 8 m. / Данные в скобках относятся к 8-метровой опорной раме.

<sup>10)</sup> **Einzelgewichte** / Single weights / Poids individuels / Singoli pesi / Tramo punta de pluma / Pesos de peças componentes / Индивидуальный вес

**Änderungen vorbehalten!** / Subject to technical modifications! /  
Sous réserves de modifications ! / Con riserva di modifiche! /  
¡Sujeto a modificaciones sin previo aviso! / Sujeto a modificaciones! /  
С правом внесения изменений!

**Sämtliche Angaben erfolgen ohne Gewähr.** / This information is supplied without liability. /  
Ces renseignements sont sans garantie. / Tutte le indicazioni fornite senza garanzia. /  
Declinamos toda responsabilidad derivada de la información proporcionada. / Declinamos  
qualquer responsabilidade quanto à informação fornecida. / Все данные указаны без обязательств.

TCS-002377-LBC-01 • EN 14439:2009 – A3 • BGL C.0.10.0355 • 04.20

Printed in Germany.

Liebherr-Werk Biberach GmbH  
Postfach 1663, D-88396 Biberach an der Riss  
☎ +49 73 51 41-0, Fax: +49 73 51 41 22 25  
www.liebherr.com, E-Mail: info.lbc@liebherr.com

Liebherr Industrias Metálicas, S.A.  
Polígono Industrial Agustinos, calle E, E-31014 Pamplona  
☎ +34 94829 70-00, Fax +34 94829 70-29  
www.liebherr.com, E-Mail: info.lim@liebherr.com